

manooi

# STOCKLIST

March 2025



## Limited Edition Artica Collection, Crafted with Crystals by Swarovski®

We are delighted to announce that through our renewed Ingredient Branding Partnership with Swarovski, our luxury crystal chandeliers are now available with 100% original Swarovski crystals.



TRANSPARENT



GOLDEN DAWN



MIDNIGHT GLOW



MYSTIC LAGOON

Manooi chandeliers are renowned for their craftsmanship and use of only the highest quality materials, with their signature brilliance coming from the use of full-cut crystals.

For clients seeking an even more refined and luxurious touch, Manooi offers the option of incorporating crystals by Swarovski - the world's most prestigious crystal brand - into their bespoke lighting creations. By integrating 100% genuine Swarovski crystals, Manooi takes the art of lighting design to new heights, combining innovation with timeless elegance. Our launch collection features our flagship Artica chandelier crafted with transparent crystals as well as three color combinations.

CRYSTALIGHT  
COLLECTION

# ARTICA

<b>Collection</b>	Crystalight
<b>Type</b>	crystal chandelier
<b>Structure</b>	polished stainless steel
<b>Trimming:</b>	full-cut crystal octagons and pendants
<b>Bulb info</b>	28 W – G9 halogen
<b>Cable</b>	transparent PVC+PVC 250 cm / 98.4 in
<b>Dimmable</b>	dimnable, phase cut



Model	Dimensions				Package				Details	Qty. pcs.
	L	W	H	kg	L	W	H	Σ kg		
<b>available for pickup</b>										
220/80	220	80	25	33	236	96	41	103		1
160/60*	160	60	19	18.5	176	76	41	60	Swarovski crystal	3
160/60*	160	60	19	18.5	176	76	41	60	Swarovski, crystal colour: Mystic Lagoon	1
160/60*	160	60	19	18.5	176	76	41	60	Swarovski, crystal colour: Midnight Glow	1
160/60*	160	60	19	18.5	176	76	41	60	Swarovski, crystal colour: Golden Dawn, gold painted structure	1
<b>available in two weeks</b>										
120/45	120	45	17	13	136	54	26	31		1
140/52	140	52	18	16	156	68	41	48		1
160/60	160	60	19	18.5	176	76	41	60		3
240/90	240	90	28	40	256	106	41	110		1

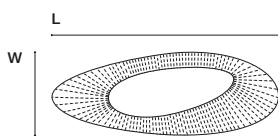

Artica

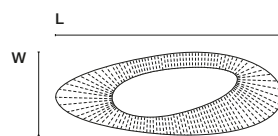

Artica +TOP

An additional sparkle on the top of a chandelier provides a gorgeous 360 degree shimmering from every perspective. The Artica model available in versions designed to be viewed from above. These versions, denoted by a '+TOP', have crystal trimmings all around their frames.

\* Custom product - differs from catalogue product

IF NOT MARKED OTHERWISE:

**Standard catalogue products.**

Safety classification IP20 for all fittings.

Units in cm, kg.

All products supplied with voltage 230, other - 110 V is available on request.

All prices are exclusive VAT and EX WORKS and do not include shipping fee and installation.

Illustrations and descriptions for informative purposes only.

All Manooi products are unique works of art and therefore may vary minimally in size, weight and colour.



# BURJ

<b>Collection</b>	Crystalight
<b>Type</b>	crystal chandelier
<b>Structure</b>	polished stainless steel
<b>Trimmings:</b>	full-cut crystal octagons
<b>Bulb info</b>	28 W – G9 halogen, 7,5 W - GU10 LED
<b>Cable</b>	transparent PVC+PVC 250 cm / 98.4 in
<b>Dimmable</b>	dimmmable, phase cut



Model	Dimensions				Package				Details	Qty.
	L	W	H	kg	L	W	H	Σ kg		
<b>available for pickup</b>										
50	100	100	50	61	121	111	91	115		1
180	100	100	180	182	121	111	218	297		1

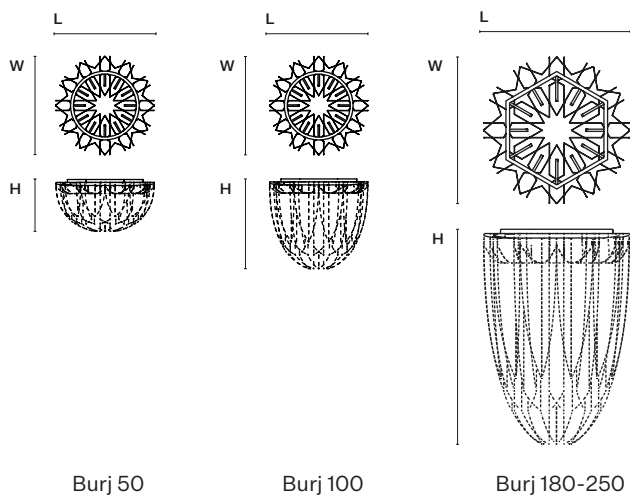

\* Custom product - differs from catalogue product

IF NOT MARKED OTHERWISE:

**Standard catalogue products.**

Safety classification IP20 for all fittings.

Units in cm, kg.

All products supplied with voltage 230, other - 110 V is available on request.

All prices are exclusive VAT and EX WORKS and do not include shipping fee and installation.

Illustrations and descriptions for informative purposes only.

All Manooi products are unique works of art and therefore may vary minimally in size, weight and colour.



# COMET L

<b>Collection</b>	Crystalight
<b>Type</b>	crystal chandelier
<b>Structure</b>	polished stainless steel
<b>Trimmings:</b>	full-cut crystal octagons
<b>Bulb info</b>	20 W/m – LED
<b>Cable</b>	transparent PVC+PVC 250 cm / 98.4 in
<b>Dimmable</b>	dimmable, push, 0-10 V, PWM, resistance



Model	Dimensions				Package				Details	Qty.
	L	W	H	kg	L	W	H	Σ kg		
<b>available in two weeks</b>										
60	60	9	6	2	70	20	15	7		1
100	100	9	6	4	110	20	15	15		1

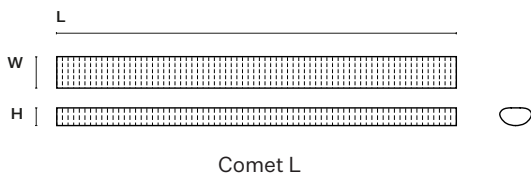

\* Custom product - differs from catalogue product

IF NOT MARKED OTHERWISE:

**Standard catalogue products.**

Safety classification IP20 for all fittings.

Units in cm, kg.

All products supplied with voltage 230, other - 110 V is available on request.

All prices are exclusive VAT and EX WORKS and do not include shipping fee and installation.

Illustrations and descriptions for informative purposes only.

All Manooi products are unique works of art and therefore may vary minimally in size, weight and colour.



# COMET C

<b>Collection</b>	Crystalight
<b>Type</b>	crystal chandelier
<b>Structure</b>	polished stainless steel
<b>Trimmings:</b>	full-cut crystal octagons
<b>Bulb info</b>	20 W/m – LED
<b>Cable</b>	transparent PVC+PVC 250 cm / 98.4 in
<b>Dimmable</b>	dimmable, push, 0-10 V, PWM, resistance



Model	Dimensions				Package				Details	Qty.
	L	W	H	kg	L	W	H	Σ kg		
<b>available in two weeks</b>										
60	60	60	6	6	70	70	15	11		1

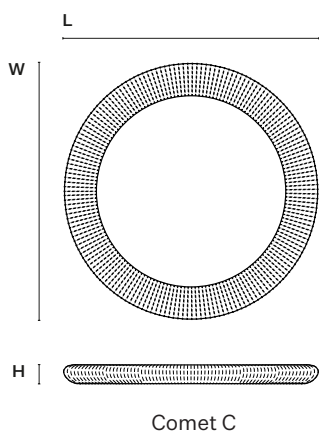

\* Custom product - differs from catalogue product

IF NOT MARKED OTHERWISE:

**Standard catalogue products.**

Safety classification IP20 for all fittings.

Units in cm, kg.

All products supplied with voltage 230, other - 110 V is available on request.

All prices are exclusive VAT and EX WORKS and do not include shipping fee and installation.

Illustrations and descriptions for informative purposes only.

All Manooi products are unique works of art and therefore may vary minimally in size, weight and colour.



# FJORD

<b>Collection</b>	Crystalight
<b>Type</b>	crystal chandelier
<b>Structure</b>	polished stainless steel
<b>Trimmings:</b>	full-cut crystal octagons and pendants
<b>Bulb info</b>	28 W – G9 halogen
<b>Cable</b>	transparent PVC+PVC 250 cm / 98.4 in
<b>Dimmable</b>	dimnable, phase cut



Model	Dimensions				Package				Details	Qty. pcs.
	L	W	H	kg	L	W	H	Σ kg		
<b>available for pickup</b>										
100/22	22	22	100	8	101	43	38	23		2
<b>available in two weeks</b>										
120/22	22	22	120	9	121	43	45	25		1
120/22	22	22	120	9	121	43	45	25		1
160/22	22	22	160	11	161	43	45	31		3
160/22	22	22	160	11	161	43	45	31		2
500/40*	40	40	500	48	195	102	84	122	custom size	1

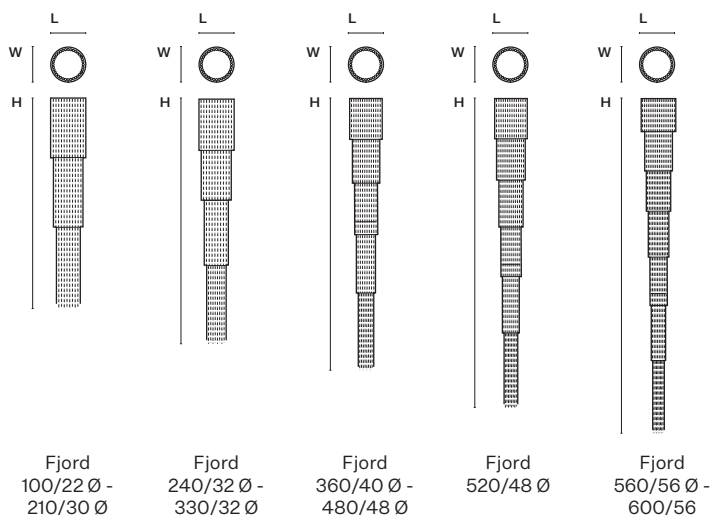

\* Custom product - differs from catalogue product

IF NOT MARKED OTHERWISE:

### Standard catalogue products.

Safety classification IP20 for all fittings.

Units in cm, kg.

All products supplied with voltage 230, other - 110 V is available on request.

All prices are exclusive VAT and EX WORKS and do not include shipping fee and installation.

Illustrations and descriptions for informative purposes only.

All Manooi products are unique works of art and therefore may vary minimally in size, weight and colour.





# ICEBERG

<b>Collection</b>	Crystalight
<b>Type</b>	crystal chandelier
<b>Structure</b>	polished stainless steel
<b>Trimmings:</b>	full-cut crystal octagons and pendants
<b>Bulb info</b>	28 W – G9 halogen
<b>Cable</b>	transparent PVC+PVC 250 cm / 98.4 in
<b>Dimmable</b>	dimnable, phase cut



Model	Dimensions				Package				Details	Qty. pcs.
	L	W	H	kg	L	W	H	Σ kg		
<b>available for pickup</b>										
70	70	70	36	12	86	86	48	34		1
40 deep	40	40	99	11	56	56	98	31		1
40 +TOP	40	40	32	7	56	56	46	20		1
<b>available in two weeks</b>										
60	60	60	32	11	76	76	4	29		1
90	90	90	41	21	106	106	76	65		3

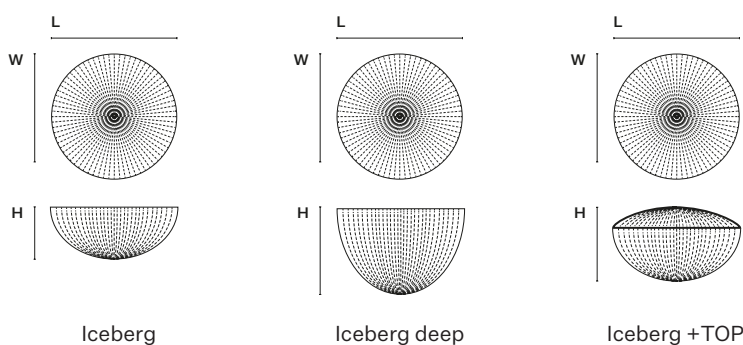

An additional sparkle on the top of a chandelier provides a gorgeous 360 degree shimmering from every perspective. The Iceberg model available in versions designed to be viewed from above. These versions, denoted by a '+TOP', have crystal trimmings all around their frames.

\* Custom product - differs from catalogue product

IF NOT MARKED OTHERWISE:

### Standard catalogue products.

Safety classification IP20 for all fittings.

Units in cm, kg.

All products supplied with voltage 230, other - 110 V is available on request.

All prices are exclusive VAT and EX WORKS and do not include shipping fee and installation.

Illustrations and descriptions for informative purposes only.

All Manooi products are unique works of art and therefore may vary minimally in size, weight and colour.



# INFINITY

<b>Collection</b>	Crystalight
<b>Type</b>	crystal chandelier
<b>Structure</b>	polished stainless steel
<b>Trimmings:</b>	full-cut crystal octagons
<b>Bulb info</b>	28 W – G9 halogen
<b>Cable</b>	transparent PVC+PVC 250 cm / 98.4 in
<b>Dimmable</b>	dimnable, phase cut



Model	Dimensions				Package				Details	Qty.
	L	W	H	kg	L	W	H	Σ kg		
<b>available in two weeks</b>										
200	200	82	28	31	216	99	57	103		1

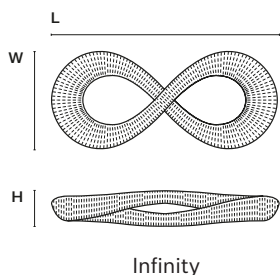

\* Custom product - differs from catalogue product

IF NOT MARKED OTHERWISE:

**Standard catalogue products.**

Safety classification IP20 for all fittings.

Units in cm, kg.

All products supplied with voltage 230, other - 110 V is available on request.

All prices are exclusive VAT and EX WORKS and do not include shipping fee and installation.

Illustrations and descriptions for informative purposes only.

All Manooi products are unique works of art and therefore may vary minimally in size, weight and colour.



# KOI

<b>Collection</b>	Crystalight
<b>Type</b>	crystal chandelier
<b>Structure</b>	polished stainless steel
<b>Trimming:</b>	full-cut crystal octagons and pendants
<b>Bulb info</b>	28 W – G9 halogen
<b>Cable</b>	transparent PVC+PVC 250 cm / 98.4 in
<b>Dimmable</b>	dimmable, phase cut



Model	Dimensions				Package				Details	Qty. pcs.
	L	W	H	kg	L	W	H	Σ kg		
<b>available for pickup</b>										
140/140	140	140	18	32	156	156	41	94		1
120/120 +TOP	120	120	22	27	136	136	51	85	crystal colour: autumn sky	1
<b>available in two weeks</b>										
80/80	80	80	17	17	96	96	26	36		1
160/160	160	160	18	39	176	176	41	124		1
160/80	160	80	18	26	176	101	41	74		1
180/110	180	110	18	32	196	131	41	97		1

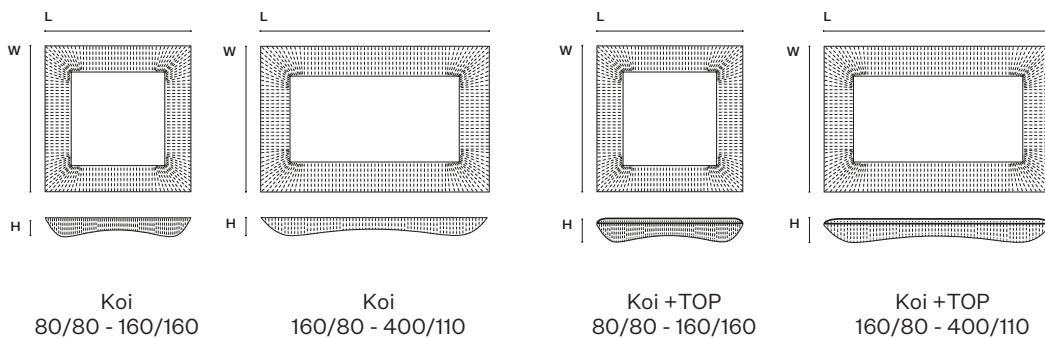

An additional sparkle on the top of a chandelier provides a gorgeous 360 degree shimmering from every perspective. The Koi model available in versions designed to be viewed from above. These versions, denoted by a '+TOP', have crystal trimmings all around their frames.

\* Custom product - differs from catalogue product

IF NOT MARKED OTHERWISE:

### Standard catalogue products.

Safety classification IP20 for all fittings.

Units in cm, kg.

All products supplied with voltage 230, other - 110 V is available on request.

All prices are exclusive VAT and EX WORKS and do not include shipping fee and installation.

Illustrations and descriptions for informative purposes only.

All Manooi products are unique works of art and therefore may vary minimally in size, weight and colour.



# LINEA

<b>Collection</b>	Crystalight
<b>Type</b>	crystal chandelier
<b>Structure</b>	polished stainless steel
<b>Trimmings:</b>	full-cut crystal octagons and pendants
<b>Bulb info</b>	28 W – G9 halogen
<b>Cable</b>	transparent PVC+PVC 250 cm / 98.4 in
<b>Dimmable</b>	dimmmable, phase cut

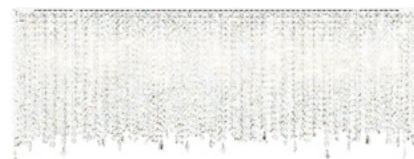

Model	Dimensions				Package				Details	Qty. pcs.
	L	W	H	kg	L	W	H	Σ kg		
<b>available for pickup</b>										
100/14	100	14	40	9	116	35	46	26		2
140/14	140	14	40	12	156	35	46	33		1
<b>available in two weeks</b>										
120/14	120	14	40	10	136	35	46	29		2
140/14	140	14	40	12	156	35	46	33		4

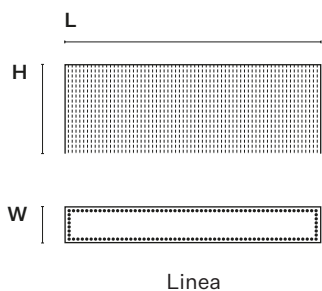

\* Custom product - differs from catalogue product

IF NOT MARKED OTHERWISE:

**Standard catalogue products.**

Safety classification IP20 for all fittings.

Units in cm, kg.

All products supplied with voltage 230, other - 110 V is available on request.

All prices are exclusive VAT and EX WORKS and do not include shipping fee and installation.

Illustrations and descriptions for informative purposes only.

All Manooi products are unique works of art and therefore may vary minimally in size, weight and colour.



# LOOP

<b>Collection</b>	Crystalight
<b>Type</b>	crystal chandelier
<b>Structure</b>	polished stainless steel
<b>Trimmings:</b>	full-cut crystal octagons and pendants
<b>Bulb info</b>	28 W – G9 halogen
<b>Cable</b>	transparent PVC+PVC 250 cm / 98.4 in
<b>Dimmable</b>	dimnable, phase cut



Model	Dimensions				Package				Details	Qty. pcs.
	L	W	H	kg	L	W	H	Σ kg		
<b>available for pickup</b>										
160	160	160	14	30	176	176	41	120		1
<b>available in two weeks</b>										
100	100	100	12	17	116	116	41	61		1
150*	150	150	13	28	166	166	41	108	custom, wide structure	1

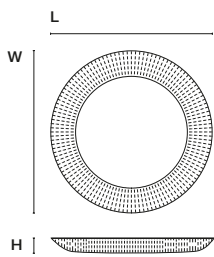

Loop  
80 - 240

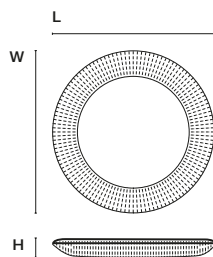

Loop + TOP  
80 - 240

An additional sparkle on the top of a chandelier provides a gorgeous 360 degree shimmering from every perspective. The Loop model available in versions designed to be viewed from above. These versions, denoted by a '+TOP', have crystal trimmings all around their frames.

\* Custom product - differs from catalogue product

IF NOT MARKED OTHERWISE:

### Standard catalogue products.

Safety classification IP20 for all fittings.

Units in cm, kg.

All products supplied with voltage 230, other - 110 V is available on request.

All prices are exclusive VAT and EX WORKS and do not include shipping fee and installation.

Illustrations and descriptions for informative purposes only.

All Manooi products are unique works of art and therefore may vary minimally in size, weight and colour.



# MIRAGE

<b>Collection</b>	Crystalight
<b>Type</b>	crystal chandelier
<b>Structure</b>	polished stainless steel
<b>Trimmings:</b>	full-cut crystal octagons - inside: transparent, outside: chrome
<b>Bulb info</b>	24W / 76W - LED
<b>Cable</b>	transparent PVC+PVC 250 cm / 98.4 in
<b>Dimmable</b>	dimnable, push, 0-10 V, PWM, resistance



Model	Dimensions				Package				Details	Qty.
	L	W	H	kg	L	W	H	Σ kg		
<b>available in two weeks</b>										
22	22	22	117	7	30	30	50	17		2
50	50	50	210	28	55	55	85	42		1

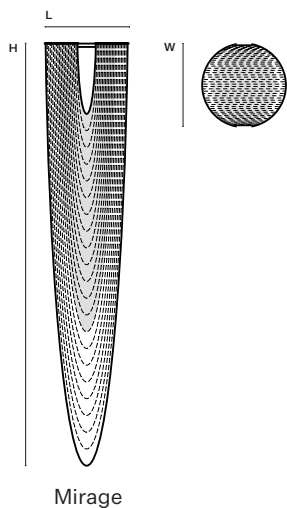

\* Custom product - differs from catalogue product

IF NOT MARKED OTHERWISE:

**Standard catalogue products.**

Safety classification IP20 for all fittings.

Units in cm, kg.

All products supplied with voltage 230, other - 110 V is available on request.

All prices are exclusive VAT and EX WORKS and do not include shipping fee and installation.

Illustrations and descriptions for informative purposes only.

All Manooi products are unique works of art and therefore may vary minimally in size, weight and colour.



# POLARIS

<b>Collection</b>	Crystalight
<b>Type</b>	crystal chandelier
<b>Structure</b>	polished stainless steel
<b>Trimming:</b>	full-cut crystal octagons
<b>Bulb info</b>	28 W – G9 halogen
<b>Cable</b>	transparent PVC+PVC 250 cm / 98.4 in
<b>Dimmable</b>	dimmmable, phase cut



Model	Dimensions				Package				Details	Qty. pcs.
	L	W	H	kg	L	W	H	Σ kg		
<b>available for pickup</b>										
70/37	70	37	14	7	86	53	26	19		1
100/53 +TOP	100	53	21	16	116	69	36	38		1
<b>available in two weeks</b>										
70/37 +TOP	70	37	18	12	86	53	36	25		1

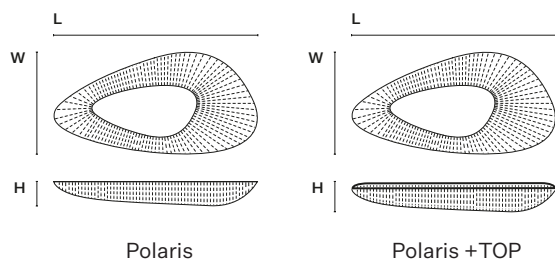

An additional sparkle on the top of a chandelier provides a gorgeous 360 degree shimmering from every perspective. The Polaris model available in versions designed to be viewed from above. These versions, denoted by a '+TOP', have crystal trimmings all around their frames.

\* Custom product - differs from catalogue product

IF NOT MARKED OTHERWISE:

### Standard catalogue products.

Safety classification IP20 for all fittings.

Units in cm, kg.

All products supplied with voltage 230, other - 110 V is available on request.

All prices are exclusive VAT and EX WORKS and do not include shipping fee and installation.

Illustrations and descriptions for informative purposes only.

All Manooi products are unique works of art and therefore may vary minimally in size, weight and colour.



# RIO

<b>Collection</b>	Crystalight
<b>Type</b>	crystal chandelier
<b>Structure</b>	polished stainless steel
<b>Trimmings:</b>	full-cut crystal octagons
<b>Bulb info</b>	28 W – G9 halogen
<b>Cable</b>	transparent PVC+PVC 250 cm / 98.4 in
<b>Dimmable</b>	dimnable, phase cut



Model	Dimensions				Package				Details	Qty.
	L	W	H	kg	L	W	H	Σ kg		
<b>available for pickup</b>										
180	180	180	22	40	196	196	41	135		1
<b>available in two weeks</b>										
120	120	120	17	20	136	136	26	52		1

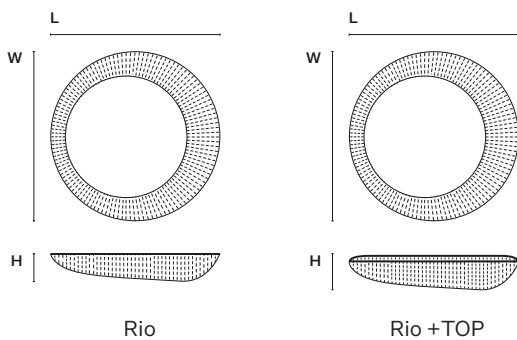

An additional sparkle on the top of a chandelier provides a gorgeous 360 degree shimmering from every perspective. The Rio model available in versions designed to be viewed from above. These versions, denoted by a '+TOP', have crystal trimmings all around their frames.

\* Custom product - differs from catalogue product

IF NOT MARKED OTHERWISE:

**Standard catalogue products.**

Safety classification IP20 for all fittings.

Units in cm, kg.

All products supplied with voltage 230, other - 110 V is available on request.

All prices are exclusive VAT and EX WORKS and do not include shipping fee and installation.

Illustrations and descriptions for informative purposes only.

All Manooi products are unique works of art and therefore may vary minimally in size, weight and colour.





# SILK

<b>Collection</b>	Crystalight
<b>Type</b>	crystal chandelier
<b>Structure</b>	polished stainless steel
<b>Trimmings:</b>	full-cut crystal octagons
<b>Bulb info</b>	18 W/m – LED
<b>Cable</b>	transparent PVC+PVC 250 cm / 98.4 in
<b>Dimmable</b>	dimmable, 1-10 V



Model	Dimensions				Package				Details	Qty.
	L	W	H	kg	L	W	H	Σ kg		
<b>available for pickup</b>										
22	22	8	80	5	37	95	20	20		1

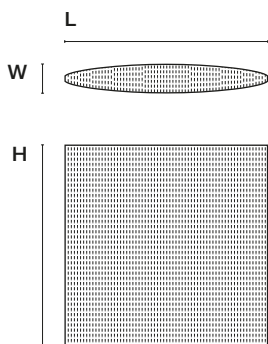

Silk

\* Custom product - differs from catalogue product

IF NOT MARKED OTHERWISE:

**Standard catalogue products.**

Safety classification IP20 for all fittings.

Units in cm, kg.

All products supplied with voltage 230, other - 110 V is available on request.

All prices are exclusive VAT and EX WORKS and do not include shipping fee and installation.

Illustrations and descriptions for informative purposes only.

All Manooi products are unique works of art and therefore may vary minimally in size, weight and colour.



# VOILE

<b>Collection</b>	Crystalight
<b>Type</b>	crystal chandelier
<b>Structure</b>	polished stainless steel
<b>Trimmings:</b>	full-cut crystal octagons
<b>Bulb info</b>	7,5 W – GU10 LED
<b>Cable</b>	transparent PVC+PVC 250 cm / 98.4 in
<b>Dimmable</b>	dimnable, phase cut



Model	Dimensions				Package				Details	Qty. pcs.
	L	W	H	kg	L	W	H	Σ kg		
<b>available for pickup</b>										
<b>C 8</b>	8	8	100	4	24	116	31	15		1
<b>Q 8/8</b>	8	8	100	4	24	116	31	14		1
<b>Q 8/16</b>	16	8	128	8	24	144	39	22		1
<b>available in two weeks</b>										
<b>Q 8/8</b>	8	8	100	4	24	116	31	14		2
<b>Q 8/8*</b>	8	8	100	4	115	23	27	19	custom chain decoration	4
<b>Q 8/16*</b>	16	8	128	6	143	23	33	24	custom chain decoration	2

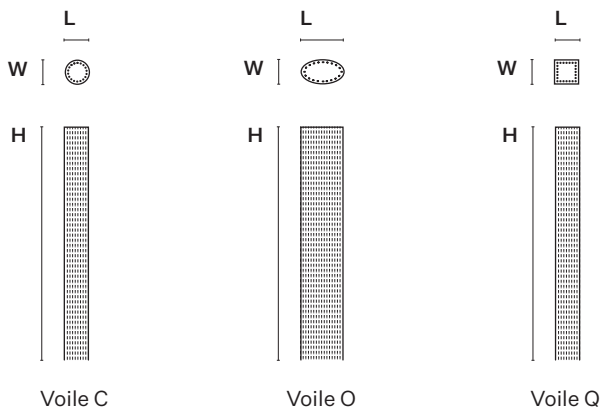

\* Custom product - differs from catalogue product

IF NOT MARKED OTHERWISE:

### Standard catalogue products.

Safety classification IP20 for all fittings.

Units in cm, kg.

All products supplied with voltage 230, other - 110 V is available on request.

All prices are exclusive VAT and EX WORKS and do not include shipping fee and installation.

Illustrations and descriptions for informative purposes only.

All Manooi products are unique works of art and therefore may vary minimally in size, weight and colour.



PERSONAL UNIVERSE  
COLLECTION

# DEEP SKY

<b>Collection</b>	Personal Universe
<b>Type</b>	crystal chandelier
<b>Structure</b>	polished SST, painted MDF/wood veneer/leather/solid surface, mirror
<b>Trimming:</b>	full-cut crystal octagons and pendants
<b>Bulb info</b>	28 W – G9 halogen
<b>Cable</b>	transparent PVC+PVC 250 cm / 98.4 in
<b>Dimmable</b>	dimnable, phase cut

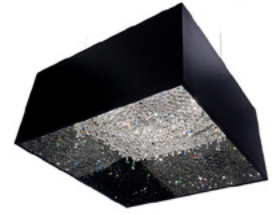

Model	Dimensions				Package				Details	Qty.
	L	W	H	kg	L	W	H	Σ kg		
<b>available for pickup</b>										
<b>80/80/40</b>	80	80	40	54	96	96	69	85	lampshade: patterned, milled solid surface	1
<b>120/120/40</b>	120	120	40	73	136	136	84	142	lampshade: patterned, milled solid surface	1
<b>160/100/28</b>	160	100	28	78	176	116	72	149	lampshade: white painted MDF	2
<b>380/30/30*</b>	380	30	30	115	395	45	60	240	custom size, lampshade: black painted MDF	1
<b>available in two weeks</b>										
<b>80/80/28*</b>	80	80	28	49	96	96	69	81	lampshade: black cowhide exterior	1

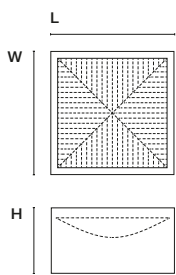

Deep Sky  
80/80 - 120/120

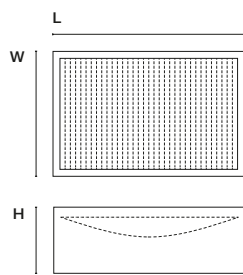

Deep Sky  
160/48 - 200/120

\* Custom product - differs from catalogue product

IF NOT MARKED OTHERWISE:

**Standard catalogue products.**

Safety classification IP20 for all fittings.

Units in cm, kg.

All products supplied with voltage 230, other - 110 V is available on request.

All prices are exclusive VAT and EX WORKS and do not include shipping fee and installation.

Illustrations and descriptions for informative purposes only.

All Manooi products are unique works of art and therefore may vary minimally in size, weight and colour.



# FINELINE

<b>Collection</b>	Personal Universe
<b>Type</b>	crystal pendant lamp
<b>Structure</b>	painted aluminium and steel
<b>Trimmings:</b>	full-cut crystal squares
<b>Bulb info</b>	18 W/m - LED
<b>Cable</b>	black FEP+PVC 250 cm / 98.4 in
<b>Dimmable</b>	dimmable, push, 1-10 V, PWM, resistance

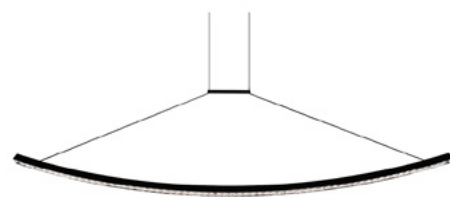

Model	Dimensions				Package				Details	Qty. pcs.
	L	W	H	kg	L	W	H	Σ kg		
<b>available for pickup</b>										
80	80	2	9	2	94	34	12	9	black painted	2
100	100	2	11	2	114	34	12	10	black painted	2
140	140	2	14	3	154	34	12	16	black painted	1
<b>available in two weeks</b>										
80	80	2	9	2	94	34	12	9	black painted	1
100	100	2	11	2	114	34	12	10	black painted	1

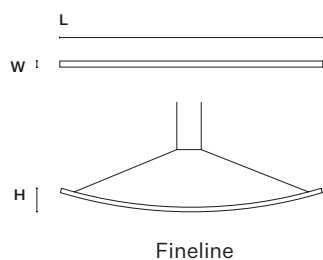

\* Custom product - differs from catalogue product

IF NOT MARKED OTHERWISE:

**Standard catalogue products.**

Safety classification IP20 for all fittings.

Units in cm, kg.

All products supplied with voltage 230, other - 110 V is available on request.

All prices are exclusive VAT and EX WORKS and do not include shipping fee and installation.

Illustrations and descriptions for informative purposes only.

All Manooi products are unique works of art and therefore may vary minimally in size, weight and colour.



# GÉODE

<b>Collection</b>	Personal Universe
<b>Type</b>	crystal pendant lamp
<b>Structure</b>	painted aluminium & polished stainless steel
<b>Trimmings:</b>	full-cut crystal beads
<b>Bulb info</b>	20 W/m – LED
<b>Cable</b>	transparent PVC+PVC 250 cm / 98.4 in
<b>Dimmable</b>	dimnable, push, 1-10 V, PWM, resistance



Model	Dimensions				Package				Details	Qty. pcs.
	L	W	H	kg	L	W	H	Σ kg		
<b>available in two weeks</b>										
<b>60</b>	60	10	5	3.5	70	20	15	9	white painted	2
<b>80</b>	80	10	5	4.5	90	20	15	13	white painted	3
<b>100</b>	100	10	5	6	110	20	15	17	white painted	2
<b>140</b>	140	10	5	7	150	20	15	22	white painted	2
<b>180</b>	180	10	5	10	190	20	15	28	white painted	1

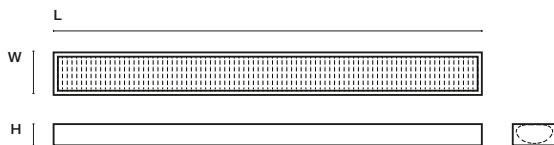

Géode

\* Custom product - differs from catalogue product

IF NOT MARKED OTHERWISE:

### Standard catalogue products.

Safety classification IP20 for all fittings.

Units in cm, kg.

All products supplied with voltage 230, other - 110 V is available on request.

All prices are exclusive VAT and EX WORKS and do not include shipping fee and installation.

Illustrations and descriptions for informative purposes only.

All Manooi products are unique works of art and therefore may vary minimally in size, weight and colour.



# HALO

<b>Collection</b>	Personal Universe
<b>Type</b>	crystal pendant lamp
<b>Structure</b>	painted aluminium
<b>Trimmings:</b>	full-cut crystal beads
<b>Bulb info</b>	20 W/m – LED
<b>Cable</b>	transparent PVC+PVC 250 cm / 98.4 in
<b>Dimmable</b>	dimmable, push, 1-10 V, PWM, resistance



Model	Dimensions				Package				Details	Qty. pcs.
	L	W	H	kg	L	W	H	Σ kg		
<b>available for pickup</b>										
H 40	40	40	3	2	61	61	19	11	black painted	1
H 54	54	54	3	2	76	76	19	16	black painted	2
H 124*	124	124	3	6	146	146	34	63	custom RGB LED, black painted	1
V 40	40	3	40	2	61	61	19	11	black painted	1
V 54	54	3	54	3	76	76	19	16	black painted	1
V 80	80	3	80	4	101	101	19	24	black painted	1
H 50*	50	50	3	2	61	61	16	7	custom size, black painted	2

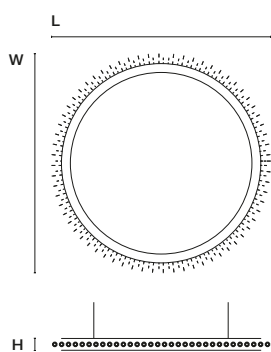

Halo  
horizontal

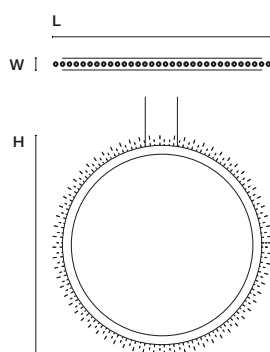

Halo  
vertical

\* Custom product - differs from catalogue product

IF NOT MARKED OTHERWISE:

### Standard catalogue products.

Safety classification IP20 for all fittings.

Units in cm, kg.

All products supplied with voltage 230, other - 110 V is available on request.

All prices are exclusive VAT and EX WORKS and do not include shipping fee and installation.

Illustrations and descriptions for informative purposes only.

All Manooi products are unique works of art and therefore may vary minimally in size, weight and colour.



# HALO

<b>Collection</b>	Personal Universe
<b>Type</b>	crystal pendant lamp
<b>Structure</b>	painted aluminium
<b>Trimmings:</b>	full-cut crystal beads
<b>Bulb info</b>	20 W/m – LED
<b>Cable</b>	transparent PVC+PVC 250 cm / 98.4 in
<b>Dimmable</b>	dimmable, push, 1-10 V, PWM, resistance



Model	Dimensions				Package				Details	Qty. pcs.
	L	W	H	kg	L	W	H	Σ kg		
<b>available in two weeks</b>										
H 40	40	40	3	2	61	61	19	11	black painted	3
H 40	40	40	3	2	61	61	19	11	white painted	3
H 54	54	54	3	2	76	76	19	16	white painted	3
H 80	80	80	3	4	101	101	19	24	black painted	1
H 80	80	80	3	4	101	101	19	24	white painted	3
V 40	40	3	40	2	61	61	19	11	black painted	1
V 80	80	3	80	4	101	101	19	24	black painted	1

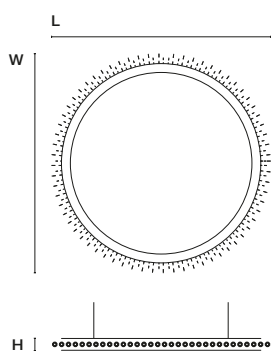

Halo  
horizontal

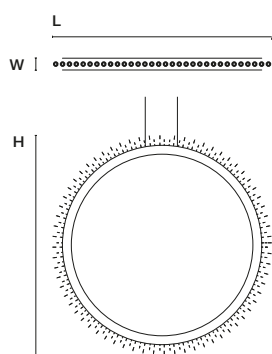

Halo  
vertical

\* Custom product - differs from catalogue product

IF NOT MARKED OTHERWISE:

**Standard catalogue products.**

Safety classification IP20 for all fittings.

Units in cm, kg.

All products supplied with voltage 230, other - 110 V is available on request.

All prices are exclusive VAT and EX WORKS and do not include shipping fee and installation.

Illustrations and descriptions for informative purposes only.

All Manooi products are unique works of art and therefore may vary minimally in size, weight and colour.





# HANABI

<b>Collection</b>	Personal Universe
<b>Type</b>	crystal pendant lamp
<b>Structure</b>	polished core, aluminium and stainless steel branches
<b>Trimming:</b>	full-cut crystal squares
<b>Bulb info</b>	18 W/m – LED
<b>Cable</b>	transparent PVC+PVC 250 cm / 98.4 in
<b>Dimmable</b>	dimnable, push, 1-10 V, PWM, resistance



Model	Dimensions				Package				Details	Qty. pcs.
	L	W	H	kg	L	W	H	Σ kg		
<b>available for pickup</b>										
spark 128	128	110	94	8	100	25	25	26		1
spark 150	150	78	72	10	100	25	25	30		1
<b>available in two weeks</b>										
spark 128	128	110	94	8	100	25	25	26		2
spark 150	150	78	72	10	100	25	25	30		2
star 100	100	100	100	8	70	25	25	31		1

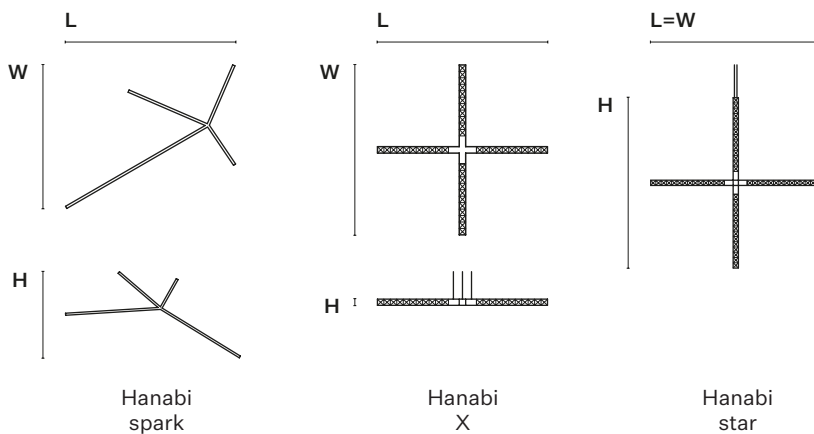

\* Custom product - differs from catalogue product

IF NOT MARKED OTHERWISE:

### Standard catalogue products.

Safety classification IP20 for all fittings.

Units in cm, kg.

All products supplied with voltage 230, other - 110 V is available on request.

All prices are exclusive VAT and EX WORKS and do not include shipping fee and installation.

Illustrations and descriptions for informative purposes only.

All Manooi products are unique works of art and therefore may vary minimally in size, weight and colour.



# ORIGO

<b>Collection</b>	Personal Universe
<b>Type</b>	crystal chandelier
<b>Structure</b>	polished or brushed copper / painted steel
<b>Trimming:</b>	full-cut crystal octagons
<b>Bulb info</b>	15 / 18 W – LED
<b>Cable</b>	black FEP+PVC 250 cm / 98.4 in
<b>Dimmable</b>	dimmable, push, 1-10 V, PWM, resistance



Model	Dimensions				Package				Details	Qty. pcs.
	L	W	H	kg	L	W	H	Σ kg		
<b>available for pickup</b>										
16	16	16	4	1	37	20	11	2	brushed copper	1
16	16	16	4	1	37	20	11	2	white painted	1
20	20	20	5	2	41	25	11	3	brushed copper	1
20	20	20	5	2	41	25	11	3	black painted	2
20	20	20	5	2	41	25	11	3	white painted	3
16*	16	16	4	1	37	20	11	2	custom structure, chrome plated	1
<b>available in two weeks</b>										
16	16	16	4	1	37	20	11	2	brushed copper	3
16	16	16	4	1	37	20	11	2	white painted	2
20	20	20	5	2	41	25	11	3	black painted	4
20*	20	20	5	2	41	25	11	3	black painted, Swarovski crystal	1

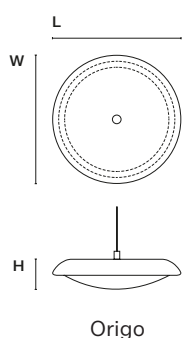

\* Custom product - differs from catalogue product

IF NOT MARKED OTHERWISE:

**Standard catalogue products.**

Safety classification IP20 for all fittings.

Units in cm, kg.

All products supplied with voltage 230, other - 110 V is available on request.

All prices are exclusive VAT and EX WORKS and do not include shipping fee and installation.

Illustrations and descriptions for informative purposes only.

All Manooi products are unique works of art and therefore may vary minimally in size, weight and colour.



# ORIGO

<b>Collection</b>	Personal Universe
<b>Type</b>	crystal chandelier
<b>Structure</b>	polished or brushed copper / painted steel
<b>Trimmings:</b>	full-cut crystal octagons
<b>Bulb info</b>	15 / 18 W – LED
<b>Cable</b>	black FEP+PVC 250 cm / 98.4 in
<b>Dimmable</b>	dimmable, push, 1-10 V, PWM, resistance



Model	Dimensions				Package				Details	Qty.
	L	W	H	kg	L	W	H	Σ kg		
<b>available in two weeks</b>										
20*	20	20	5	2	41	25	11	3	custom polished copper, Swarovski crystal	1

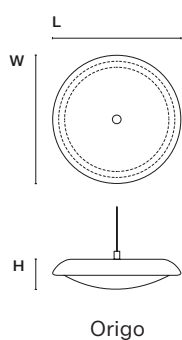

\* Custom product - differs from catalogue product

IF NOT MARKED OTHERWISE:

**Standard catalogue products.**

Safety classification IP20 for all fittings.

Units in cm, kg.

All products supplied with voltage 230, other - 110 V is available on request.

All prices are exclusive VAT and EX WORKS and do not include shipping fee and installation.

Illustrations and descriptions for informative purposes only.

All Manooi products are unique works of art and therefore may vary minimally in size, weight and colour.



# ORIGO STAR

<b>Collection</b>	Personal Universe
<b>Type</b>	crystal chandelier
<b>Structure</b>	black painted steel, polished or brushed copper / painted steel
<b>Trimmings:</b>	full-cut crystal octagons
<b>Bulb info</b>	15 & 18 W – LED
<b>Cable</b>	black FEP+PVC 250 cm / 98.4 in
<b>Dimmable</b>	dimmable, push, 1-10 V, PWM, resistance



Model	Dimensions				Package				Details	Qty.
	L	W	H	kg	L	W	H	Σ kg		
<b>available for pickup</b>										
116	116	116	7	16	103	89	45	52	polished copper/black painted	1
<b>available in two weeks</b>										
star set	150	150	50	56	103	89	73	126	brushed copper/black painted	1

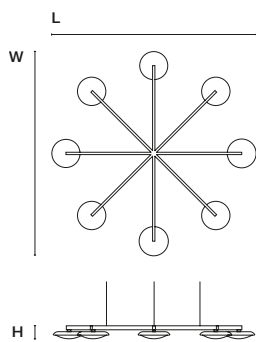

Origo  
star

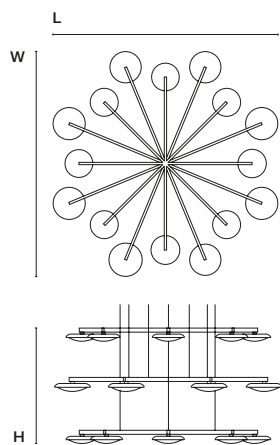

Origo  
star set

\* Custom product - differs from catalogue product

IF NOT MARKED OTHERWISE:

## Standard catalogue products.

Safety classification IP20 for all fittings.

Units in cm, kg.

All products supplied with voltage 230, other - 110 V is available on request.

All prices are exclusive VAT and EX WORKS and do not include shipping fee and installation.

Illustrations and descriptions for informative purposes only.

All Manooi products are unique works of art and therefore may vary minimally in size, weight and colour.



# ORIGO PULSAR

<b>Collection</b>	Personal Universe
<b>Type</b>	crystal chandelier
<b>Structure</b>	black painted steel, polished or brushed copper / painted steel
<b>Trimmings:</b>	full-cut crystal octagons
<b>Bulb info</b>	15 & 18 W – LED
<b>Cable</b>	black FEP+PVC 250 cm / 98.4 in
<b>Dimmable</b>	dimmable, push, 1-10 V, PWM, resistance



Model	Dimensions				Package				Details	Qty.
	L	W	H	kg	L	W	H	Σ kg		
<b>available in two weeks</b>										
pulsar*	130	130	170	45	141	141	211	155	Spectra crystal, polished copper/black painted	1

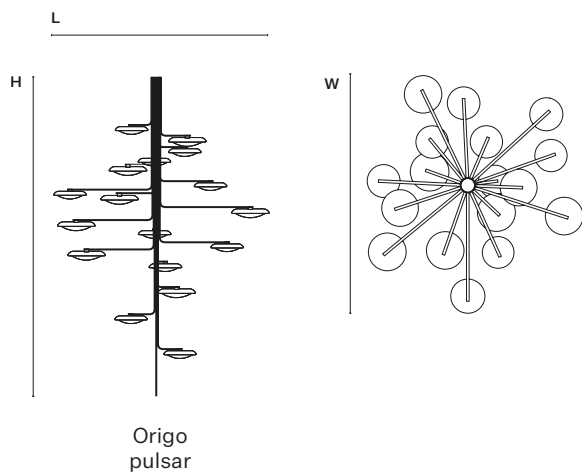

\* Custom product - differs from catalogue product

IF NOT MARKED OTHERWISE:

**Standard catalogue products.**

Safety classification IP20 for all fittings.

Units in cm, kg.

All products supplied with voltage 230, other - 110 V is available on request.

All prices are exclusive VAT and EX WORKS and do not include shipping fee and installation.

Illustrations and descriptions for informative purposes only.

All Manooi products are unique works of art and therefore may vary minimally in size, weight and colour.



# ORIGO CONE

<b>Collection</b>	Personal Universe
<b>Type</b>	crystal pendant lamp
<b>Structure</b>	brushed copper / painted steel
<b>Trimmings:</b>	full-cut crystal octagons
<b>Bulb info</b>	6 / 15 / 18 W – LED
<b>Cable</b>	black FEP+PVC 250 cm / 98.4 in
<b>Dimmable</b>	dimmable, push, 1-10 V, PWM, resistance



Model	Dimensions				Package				Details	Qty. pcs.
	L	W	H	kg	L	W	H	Σ kg		
<b>available for pickup</b>										
20/16	20	20	16	1	42	26	21	2	brushed copper	1
20/16	20	20	16	1	42	26	21	2	black painted	2
24/18	24	24	18	2	45	29	22	3	black painted	1
24/18	24	24	18	2	45	29	22	3	white painted	1
20/16*	20	20	16	1	42	26	21	2	custom structure, polished copper	1
<b>available in two weeks</b>										
10/24	10	10	24	1	27	15	28	2	brushed copper	1
10/24	10	10	24	1	27	15	28	2	black painted	2
10/24	10	10	24	1	27	15	28	2	white painted	2
20/16	20	20	16	1	42	26	21	2	brushed copper	1
20/16	20	20	16	1	42	26	21	2	black painted	1

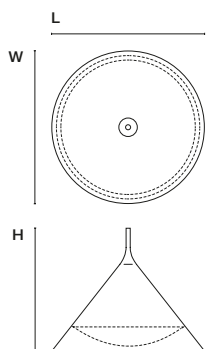

Origo  
cone  
20/16 - 24/18

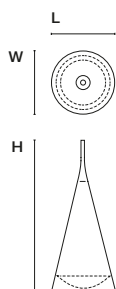

Origo  
cone  
10/24

\* Custom product - differs from catalogue product

IF NOT MARKED OTHERWISE:

### Standard catalogue products.

Safety classification IP20 for all fittings.

Units in cm, kg.

All products supplied with voltage 230, other - 110 V is available on request.

All prices are exclusive VAT and EX WORKS and do not include shipping fee and installation.

Illustrations and descriptions for informative purposes only.

All Manooi products are unique works of art and therefore may vary minimally in size, weight and colour.



# ORIGO TUBE

<b>Collection</b>	Personal Universe
<b>Type</b>	crystal pendant lamp
<b>Structure</b>	brushed copper / painted steel
<b>Trimmings:</b>	full-cut crystal octagons
<b>Bulb info</b>	6 W – LED
<b>Cable</b>	black FEP+PVC 250 cm / 98.4 in
<b>Dimmable</b>	dimmable, push, 1-10 V, PWM, resistance



Model	Dimensions				Package				Details	Qty. pcs.
	L	W	H	kg	L	W	H	Σ kg		
<b>available for pickup</b>										
9/9	9	9	9	2	26	14	13	3	brushed copper	1
9/9	9	9	9	2	26	14	13	3	black painted	4
9/45	9	9	9	2	26	14	13	3	white painted	2
9/45	9	9	45	3	66	14	13	4	brushed copper	4
<b>available in two weeks</b>										
9/9	9	9	9	2	26	17	13	3	brushed copper	2
9/45	9	9	45	3	66	14	14	4	white painted	2
9/45*	9	9	45	3	66	14	14	4	custom structure, polished copper	1

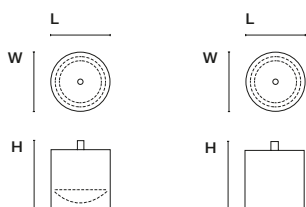

Origo tube  
9/9

Origo tube  
9/45

\* Custom product - differs from catalogue product

IF NOT MARKED OTHERWISE:

### Standard catalogue products.

Safety classification IP20 for all fittings.

Units in cm, kg.

All products supplied with voltage 230, other - 110 V is available on request.

All prices are exclusive VAT and EX WORKS and do not include shipping fee and installation.

Illustrations and descriptions for informative purposes only.

All Manooi products are unique works of art and therefore may vary minimally in size, weight and colour.



# OZERO

<b>Collection</b>	Personal Universe
<b>Type</b>	crystal chandelier
<b>Structure</b>	fibreglass & polished stainless steel
<b>Trimmings:</b>	full-cut crystal octagons and pendants
<b>Bulb info</b>	28 W – G9 halogen
<b>Cable</b>	transparent PVC+PVC 250 cm / 98.4 in
<b>Dimmable</b>	dimmable, phase cut



Model	Dimensions				Package				Details	Qty.
	L	W	H	kg	L	W	H	Σ kg		
<b>available for pickup</b>										
100	100	100	88	35	116	116	92	95	white painted	1

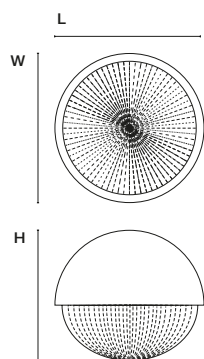

Ozero  
60 - 100

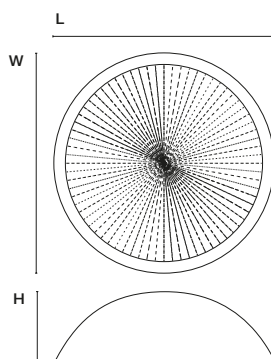

Ozero  
180

\* Custom product - differs from catalogue product

IF NOT MARKED OTHERWISE:

**Standard catalogue products.**

Safety classification IP20 for all fittings.

Units in cm, kg.

All products supplied with voltage 230, other - 110 V is available on request.

All prices are exclusive VAT and EX WORKS and do not include shipping fee and installation.

Illustrations and descriptions for informative purposes only.

All Manooi products are unique works of art and therefore may vary minimally in size, weight and colour.





# TONDO

<b>Collection</b>	Personal Universe
<b>Type</b>	crystal pendant lamp
<b>Structure</b>	painted steel & polished stainless steel
<b>Trimmings:</b>	full-cut crystal octagons and pendants
<b>Bulb info</b>	28 W – G9 halogen
<b>Cable</b>	black / white textile 250 cm / 98.4 in
<b>Dimmable</b>	dimnable, phase cut



Model	Dimensions				Package				Details	Qty.
	L	W	H	kg	L	W	H	Σ kg		
<b>available for pickup</b>										
36	36	36	10	5	52	62	26	13	black painted	1
36*	36	36	10	5	52	62	26	13	custom colour, gold & black painted	1
<b>available in two weeks</b>										
36	36	36	10	5	52	62	26	13	black painted	2

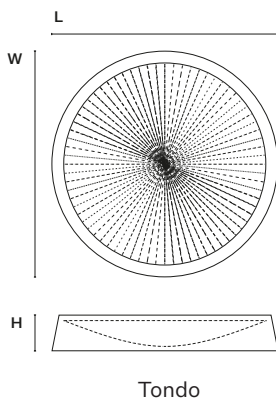

\* Custom product - differs from catalogue product

IF NOT MARKED OTHERWISE:

**Standard catalogue products.**

Safety classification IP20 for all fittings.

Units in cm, kg.

All products supplied with voltage 230, other - 110 V is available on request.

All prices are exclusive VAT and EX WORKS and do not include shipping fee and installation.

Illustrations and descriptions for informative purposes only.

All Manooi products are unique works of art and therefore may vary minimally in size, weight and colour.



# WISSH

<b>Collection</b>	Personal Universe
<b>Type</b>	crystal pendant lamp
<b>Structure</b>	painted steel & polished stainless steel
<b>Trimmings:</b>	full-cut crystal beads
<b>Bulb info</b>	28 W – G9 halogen
<b>Cable</b>	transparent PVC+PVC 250 cm / 98.4 in
<b>Dimmable</b>	dimnable, phase cut



Model	Dimensions				Package				Details	Qty.
	L	W	H	kg	L	W	H	Σ kg		
<b>available in two weeks</b>										
500*	500	40	88	45	420	50	41	65	custom size, black painted, Swarovski crystal	1

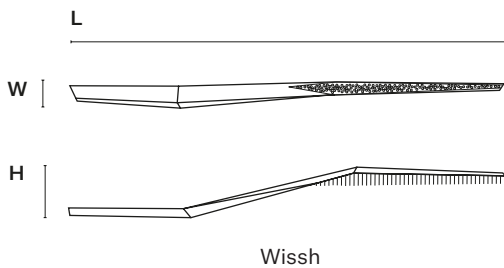

\* Custom product - differs from catalogue product

IF NOT MARKED OTHERWISE:

**Standard catalogue products.**

Safety classification IP20 for all fittings.

Units in cm, kg.

All products supplied with voltage 230, other - 110 V is available on request.

All prices are exclusive VAT and EX WORKS and do not include shipping fee and installation.

Illustrations and descriptions for informative purposes only.

All Manooi products are unique works of art and therefore may vary minimally in size, weight and colour.



GEM  
COLLECTION

# JEWEL CEILING

<b>Collection</b>	Gem
<b>Type</b>	onyx pendant lamp
<b>Structure</b>	painted steel ceiling box, silicone core with onyx shade (pearl/cylinder)
<b>Bulb info:</b>	10W/m - LED
<b>Dimmable</b>	dimmable, push, 0-10 V, PWM, resistance



Model	Dimensions				Package				Details	Qty.
	L	W	H	kg	L	W	H	Σ kg		
<b>available for pickup</b>										
100 U - 4 m	100	5	191	17	141	60	18	42	black painted ceiling box, onyx cylinders	1
100 U - 5 m	100	5	242	20	141	76	18	50	black painted ceiling box, onyx cylinders	1

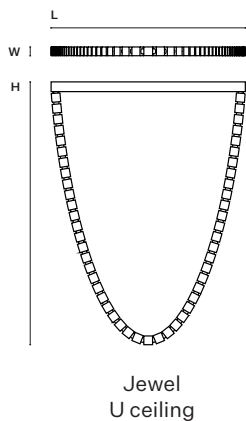

\* Custom product - differs from catalogue product

IF NOT MARKED OTHERWISE:

**Standard catalogue products.**

Safety classification IP20 for all fittings.

Units in cm, kg.

All products supplied with voltage 230, other - 110 V is available on request.

All prices are exclusive VAT and EX WORKS and do not include shipping fee and installation.

Illustrations and descriptions for informative purposes only.

All Manooi products are unique works of art and therefore may vary minimally in size, weight and colour.



# JEWEL SUSPENDED

<b>Collection</b>	Gem
<b>Type</b>	onyx pendant lamp
<b>Structure</b>	silicone core with onyx module (pearl/cylinder)
<b>Bulb info:</b>	10W/m - LED
<b>Cable</b>	white PVC+PVC 250 cm / 98.4 in
<b>Dimmable</b>	dimnable, push, 0-10 V, PWM, resistance



Model	Dimensions				Package				Details	Qty.
	L	W	H	kg	L	W	H	Σ kg		
<b>available for pickup</b>										
2 m	200	5	5	7	141	60	18	32	onyx pearls	1

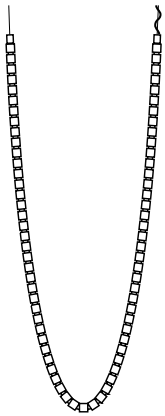

Jewel  
suspended



\* Custom product - differs from catalogue product

IF NOT MARKED OTHERWISE:

## Standard catalogue products.

Safety classification IP20 for all fittings.

Units in cm, kg.

All products supplied with voltage 230, other - 110 V is available on request.

All prices are exclusive VAT and EX WORKS and do not include shipping fee and installation.

Illustrations and descriptions for informative purposes only.

All Manooi products are unique works of art and therefore may vary minimally in size, weight and colour.



FLOOR, WALL &  
TABLE LAMPS

# LINEA W

<b>Collection</b>	Crystalight
<b>Type</b>	crystal wall lamp
<b>Structure</b>	polished stainless steel
<b>Trimmings:</b>	full-cut crystal octagons and pendants
<b>Bulb info</b>	28 W – G9 halogen
<b>Dimmable</b>	dimmable, phase cut

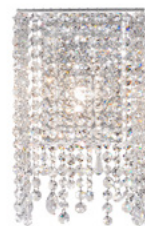

Model	Dimensions				Package				Details	Qty. pcs.
	L	W	H	kg	L	W	H	Σ kg		
<b>available for pickup</b>										
16/35	16	9	35	2	38	38	24	7		4
16/35	16	9	35	2	38	38	24	7	gold varnished structure	1
16/35	16	9	35	2	38	38	24	7	crystal colour: aurora borealis	1
16/35	16	9	35	2	38	38	24	7	crystal colour: autumn night	1
16/35	16	9	35	2	38	38	24	7	crystal colour: autumn sky	1
16/35	16	9	35	2	38	38	24	7	crystal colour: cherry blossom	1
16/35	16	9	35	2	38	38	24	7	crystal colour: spring flowers	1
16/35	16	9	35	2	38	38	24	7	crystal colour: summer breeze	1
16/35	16	9	35	2	38	38	24	7	crystal colour: summer heat	1
16/35	16	9	35	2	38	38	24	7	crystal colour: winter pines	1
16/35	16	9	35	2	38	38	24	7	crystal colour: winter sky	1
16/35*	16	9	35	2	38	38	24	7	custom design for yachts	1

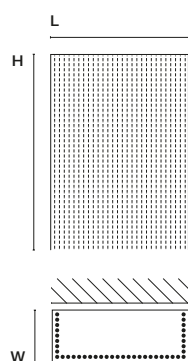

Linea W

\* Custom product - differs from catalogue product

IF NOT MARKED OTHERWISE:

**Standard catalogue products.**

Safety classification IP20 for all fittings.

Units in cm, kg.

All products supplied with voltage 230, other - 110 V is available on request.

All prices are exclusive VAT and EX WORKS and do not include shipping fee and installation.

Illustrations and descriptions for informative purposes only.

All Manooi products are unique works of art and therefore may vary minimally in size, weight and colour.



# LINEA W

<b>Collection</b>	Crystalight
<b>Type</b>	crystal wall lamp
<b>Structure</b>	polished stainless steel
<b>Trimmings:</b>	full-cut crystal octagons and pendants
<b>Bulb info</b>	28 W – G9 halogen
<b>Dimmable</b>	dimmable, phase cut

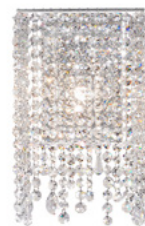

Model	Dimensions				Package				Details	Qty. pcs.
	L	W	H	kg	L	W	H	Σ kg		
<b>available for pickup</b>										
20/35	20	9	35	2	38	38	24	7		5
25/35	25	9	35	3	38	43	24	8		3
40/35	40	9	35	3	56	44	24	8		4
60/35	60	9	35	4	81	41	24	14		3
20/35*	20	9	35	2	38	38	24	7	crystal colour: aurora borealis, Swarovski crystal	1
<b>available in two weeks</b>										
40/35	40	9	35	3	56	44	24	10		1
60/35	60	9	35	4	81	41	24	14		1
120/35*	120	9	35	9	141	41	24	23	custom design with E14 bulbs	1

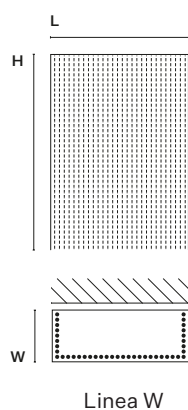

\* Custom product - differs from catalogue product

IF NOT MARKED OTHERWISE:

### Standard catalogue products.

Safety classification IP20 for all fittings.

Units in cm, kg.

All products supplied with voltage 230, other - 110 V is available on request.

All prices are exclusive VAT and EX WORKS and do not include shipping fee and installation.

Illustrations and descriptions for informative purposes only.

All Manooi products are unique works of art and therefore may vary minimally in size, weight and colour.





# LINEA T

<b>Collection</b>	Crystalight
<b>Type</b>	crystal table lamp
<b>Structure</b>	polished stainless steel
<b>Trimmings:</b>	full-cut crystal octagons and pendants
<b>Bulb info</b>	28 W – G9 halogen
<b>Cable</b>	150 cm / 59.1 in
<b>Dimmable</b>	dimmable, phase cut



Model	Dimensions				Package				Details	Qty.
	L	W	H	kg	L	W	H	Σ kg		
<b>available in two weeks</b>										
60	60	16	40	15	76	30	58	27		1

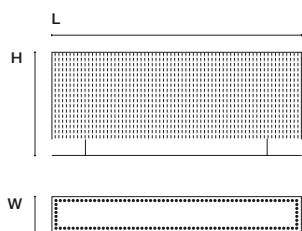

Linea T

\* Custom product - differs from catalogue product

IF NOT MARKED OTHERWISE:

**Standard catalogue products.**

Safety classification IP20 for all fittings.

Units in cm, kg.











All products supplied with voltage 230, other - 110 V is available on request.

All prices are exclusive VAT and EX WORKS and do not include shipping fee and installation.

Illustrations and descriptions for informative purposes only.

All Manooi products are unique works of art and therefore may vary minimally in size, weight and colour.



L	length
W	width
H	height
∅	diameter
	~110 V
	~230 V
	product conform to European Community Directive
	fixable to ceiling
	fixable to wall
	floor lamp
	table lamp
	G9 halogen
	LED
	only basic insulation, accessible conductors are earthed earthing: compulsory



CHERRY BLOSSOM



SUMMER BREEZE



SUMMER HEAT



SPRING FLOWERS



AUTUMN SKY



WINTER SKY

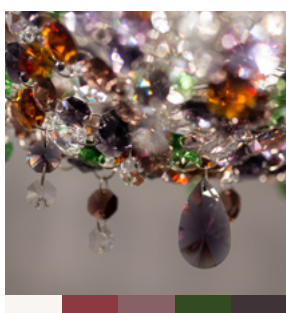

AUTUMN NIGHT



WINTER PINES



AURORA BOREALIS

In the making of Manooi's chandeliers, only the best quality crystals are used.

Colours can be chosen to best complement the space in which the chandelier will be placed. These examples are just a few of the almost infinite possibilities.



Polished  
Stainless Steel

Painted  
Gold Colour

Manooi has chosen to manufacture frames out of stainless steel due to its longevity and strength.



Most of our standard chandeliers are also available in a version designed to be viewed from above.

This version, denoted by „+TOP”, has crystal trimmings all around the frame so that the visual effect is the same from above as from below.



12.03.2025